

## DS2000 dewpoint meter

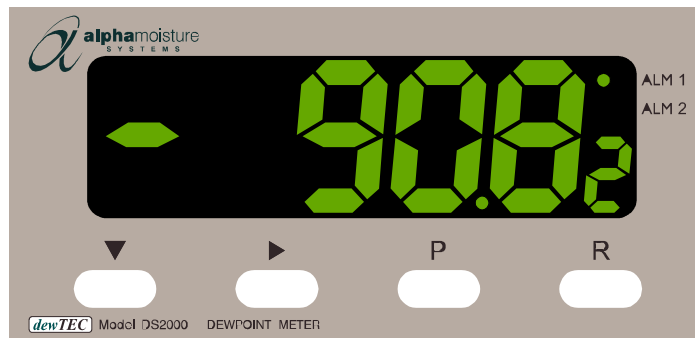

# instruction manual

alpha moisture systems  
alpha house, 96 city road  
bradford, BD8 8ES  
england

Tel: +44 1274 733100  
Fax: +44 1274 733200  
Email: [info@amsystems.co.uk](mailto:info@amsystems.co.uk)  
Web: [www.amsystems.co.uk](http://www.amsystems.co.uk)



## HOW TO USE THIS MANUAL

***IMPORTANT: USER MUST READ THIS MANUAL BEFORE OPERATING THE dewTEC DS2000 DEWPOINT METER***

This manual comprises of six sections *viz.*

- Section 1      General Description**  
Includes general description outlining the main features of the unit.
  
- Section 2      Installation Instructions**  
Safety Information  
Unpacking your dewTEC DS2000 and Moisture Sensor  
Sensor Care  
Sensor Installation  
Dew Point Meter Installation  
Electrical Connections  
External AUTOCAL Control
  
- Section 3      Operating Instructions**  
Start Up  
Front Panel Display and Keys  
Viewing Pre-Set Parameters  
Alarm Settings  
Resetting a Latched Alarm
  
- Section 4      dewTEC DS2000 Settings**  
AUTOCAL  
Factory Set Parameters  
Calibration Data, Analogue Output Span, Offset, Filter, Serial Communications, Display Colour, Lock, Help, Alarm Mode and Direction, Analogue Output Type, Totaliser.
  
- Section 5      RS485 Serial Communications**  
Data Format  
Protocol  
Message Form
  
- Section 6      Maintenance and Trouble Shooting**  
Maintenance  
Problem Guide
  
- Appendices    Specifications and General Arrangement**



# CONTENTS

HOW TO USE THIS MANUAL	iii
<b>1.0 General Description &amp; Features</b>	<b>1</b>
1.1 Description	1
1.2 Main Features	1
1.2.1 Dewpoint Meter Features	1
1.2.2 Sensor Features	1
<b>2.0 Installation Instructions</b>	<b>2</b>
2.1 Safety Information	2
2.1.1 Warning	2
2.1.2 Isolation	2
2.2 Unpacking your <i>dewTEC</i> DS2000 Dewpoint Meter and Sensor	2
2.3 Sensor Care	2
2.4 Installing the air/gas sampling system	3
2.5 Installing and commissioning the sensor	5
2.6 Installing your <i>dewTEC</i> DS2000 Hygrometer	6
2.6.1 Panel mounting cut out	6
2.6.2 Panel mounting	6
2.7 Electrical interface connections	6
2.7.1 Mains (line) supply	7
2.7.2 Sensor Connection	7
2.7.3 Alarm Relay Outputs	7
2.7.4 Linear (Analogue re-transmission) Output	7
2.7.5 Alarm Transistor Open Collector Outputs	7
2.7.6 Serial Communications Output	8
2.7.7 External Autocal Control	8
<b>3.0 Operating Instructions</b>	<b>9</b>
3.1 Start Up	9
3.2 Front Panel Display and Keys	9
3.3 Viewing Operating Mode Parameters	10
3.4 Setting the Alarms and hysteresis	11
3.5 Hysteresis Operation	12
3.6 Resetting a latched Alarm	12
<b>4.0 Hygrometer Settings</b>	<b>13</b>
4.1 Sensor Calibration (AUTOCAL)	13
4.2 Programmed Settings	14
4.2.1 Program Mode	14
4.2.2 Configuration Mode	16
<b>5.0 Serial Communications</b>	<b>18</b>
5.1 Data Format/Baud Rate	18
5.2 Protocol	18
5.3 Message Format	18
5.3.1 Message Form 1	18
5.3.2 Message Form 2	19
5.4 Error Conditions	19
<b>6.0 Maintenance and Troubleshooting</b>	<b>20</b>
6.1 Maintenance	20
6.2 Problem Guide	20
<b>Appendices</b>	<b>22</b>
Appendix A – Product Specification	22
Appendix B – General Arrangement	23



## 1.0 General Description & Features

### 1.1 Description

The *dewTEC* DS2000 is a DIN style panel mounted dewpoint meter, designed to accurately measure the dewpoint in gas or dry compressed air. The operating range of the unit is factory set to the Moisture Sensor supplied with the unit. Process moisture value in factory set units of °C, °F or PPM(V) is indicated, by the *dewTEC* DS2000 dewpoint meter, on a large five digit seven segment display

The main external body of the Ultra High Capacitance Moisture Sensor is made of plated steel and a stainless steel filter guard protects the sensing element within it.

The sensor can be located up to one kilometre away from the dew point meter.

### 1.2 Main Features

#### 1.2.1 Dewpoint Meter Features

The *dewTEC* DS2000 dewpoint meter's main features are:

- Display: Five large LED digits and one small LED digit, both with seven segments. Two alarm status LED's.
- User programmable LED indication to display in either Green or Red and can be programmed to change colour when in alarm condition.
- Programmable via push button keys on front panel or PC (optional extra).
- Alarms: Two, independent, fully user programmable isolated relays with open collector outputs. Programmable lock out to avoid unauthorised tamper.
- Displays maximum and minimum values.
- Displays elapsed time from alarm condition.
- Factory set calibration data in °C, °F or PPM.
- Factory set current (mA) OR voltage (mV) analogue output. Isolated and user programmable to span over any range, within the overall range of the sensor.
- RS485 serial output with 1-99 address settings.
- 90 - 264V, 50/60Hz Universal input power supply.
- Accuracy  $\pm 2^{\circ}\text{C}$  dewpoint (or equivalent in other moisture units).
- AUTOCAL feature for automatic calibration adjustment.

#### 1.2.2 Sensor Features

The sensor main features are:

- Various dewpoint ranges available. Range ident on sensor packaging.
- Conditioned for long term stability.
- Can be located up to 1km from the *dewTEC* DS2000 dewpoint meter, connected by a low impedance coaxial cable.
- ATEX Certified for use in potentially explosive areas with suitable Zener Barrier.

## 2.0 Installation Instructions

### 2.1 Safety Information

**Before installation** please read the safety information below.

#### 2.1.1 Warning

Suitably qualified personnel must install the equipment and care must be taken, as high voltages may be present on the instrument terminals. The instrument must be mounted in a position that provides protection behind the panel to at least IP20. Local regulations regarding electrical installation should be rigidly observed.

#### 2.1.2 Isolation

The power supply terminals and associated internal circuitry are isolated from all other parts of the equipment, in accordance with EN61010-1, for connection to a category II supply (pollution degree 2). Any terminals or wiring connected to the input or output, which is accessible in normal operation, must only be connected to signals complying with the requirements for Safety Extra Low Voltage (SELV) circuits.

Follow wiring instructions described later in this section.

### 2.2 Unpacking your *dewTEC* DS2000 Dewpoint Meter and Sensor

Once unpacked, the items should be examined for any obvious external damage. Any evidence of damage or mishandling should be notified to your carrier immediately.

The items should include *dewTEC* DS2000 dewpoint meter, Moisture Sensor packed in a metal canister, instruction manual, sensor connecting cable and any optional extras if ordered. The sensor is packed separately in a waterproof metal canister, with desiccant, to protect it from excessive moisture exposure during transit. The sensor should be inspected for damage then immediately stored in its canister until ready for installation. Retain the packaging for future use, ensuring the sensor canister cap is tightly screwed to preserve the desiccant.

### 2.3 Sensor Care

Very special care must be taken not to damage the sensing element, for example by touching or making any other physical contact, as this may damage the sensing surface and render the Sensor useless.

Additionally, the following guidelines should always be followed:

- For any reason whatsoever **DO NOT REMOVE THE SENSOR GUARD OR ATTEMPT TO CLEAN THE SENSING ELEMENT WITHIN IT.** The Sensor is NOT user serviceable and does NOT contain any user replaceable parts. In the event of a problem follow the problem guide at the end of this manual.



- When not in use the sensor should always be stored in the desiccant contained metal canister.
- The sensor should not be exposed to ambient conditions for considerably long periods.
- Exposure of the sensor to liquid water or condensing atmospheres should be avoided.
- The sensor should not be exposed to corrosive contaminants such as chlorine, ammonia or mercury vapours. These gasses will gradually corrode the sensor and cause a loss of sensitivity, hence affecting the system accuracy.
- Avoid heat sources and extreme temperatures when choosing installation site
- Ensure the sample gas exposed to the sensor is clean as contaminants such as oil, glycol and heavy hydrocarbons can mask the sensing element, thus affecting the system response. *(If this is an issue contact your dewTEC DS2000 supplier for advice on a suitable sample system.)*

## 2.4 Installing the air/gas sampling system

The piping installation schematic diagram below shows all components, which could be used in a dry gas measurement application although not all the items shown will be required for every installation.

Care should be taken to ensure that the sample presented to the measuring sensor is not contaminated with any component that will damage, contaminate or affect the sensor in a way that will impair the system accuracy.

It is strongly recommended that the sample should not contain particulate matter, oil or other heavy hydrocarbon condensate. If these components contaminate the sample system and/or the measuring sensor, the system response time will be lengthened, although the sensor calibration will not be effected.

**The sample must not contain Ammonia, Chlorine, Ozone or any wet acid vapours or liquid as these will permanently damage the sensor and impair calibration accuracy.**

The flow rate, although not critical to the sensor measurement, should be low enough to avoid abrasion to the sensor surface without being so low as to extend the system response time to an unacceptable level. In general, a flow rate of between 2 and 3 litres/min at NTP will give the right balance.

The sensor is a variable capacitor, which is directly affected by changes in partial pressure of water vapour, and these changes, that are proportional to the dew/frost point temperature, are displayed on the hygrometer display.

The measuring sensor can be installed directly into the process line but this does create problems with access for maintenance and calibration. It is for these reasons that we recommend that the sensor be installed in a bypass, fast loop or total loss sample system where the sensor is accessible without interrupting the main process flow line.

## Piping installation Schematic

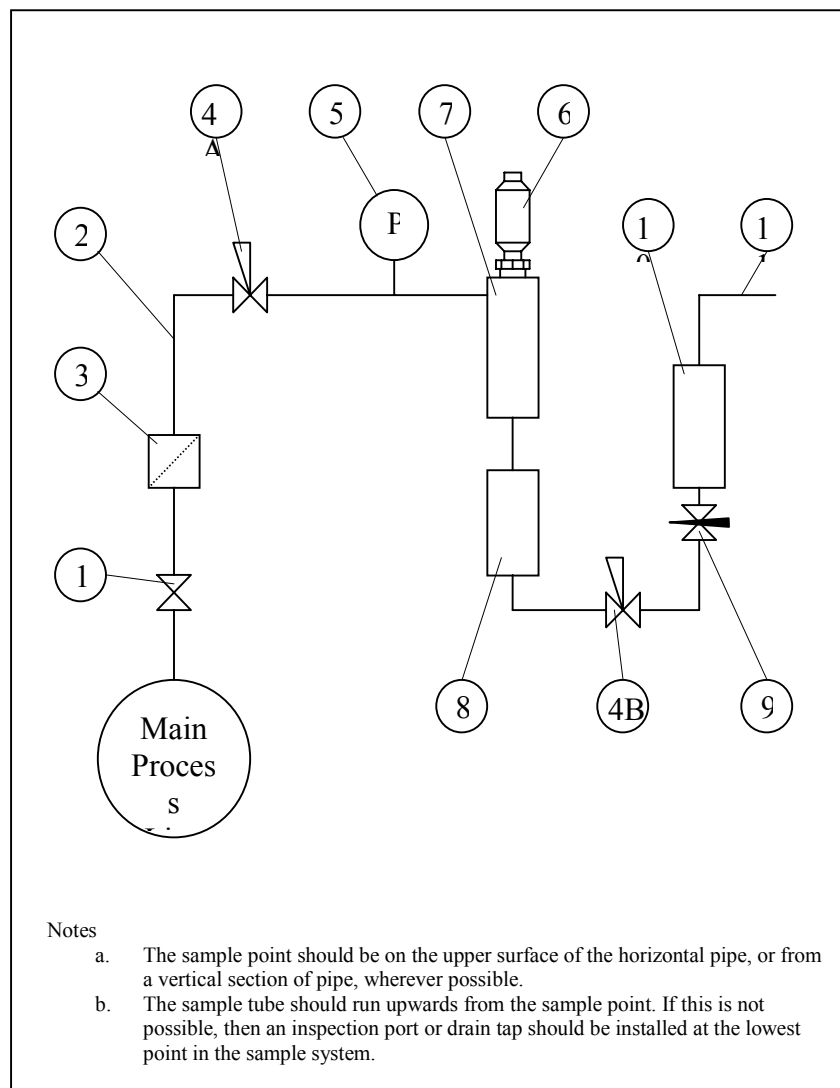

### Piping Schematic Component Index

- 1) *Sample Isolation Valve* - This is a recommended item as it allows access to the sample system without interrupting the main process line.
- 2) *Sample Tube* – This should be stainless steel for dry air or gas applications but copper or carbon steel can be used where wetter gases are to be measured. If any section of the sample tube must be flexible then PTFE should be used. In most cases, 3mm OD (1/8”) is sufficient as it provides good system response time within minimum flow. 6mm OD (1/4”) tube can be used where pressure drops across the 3mm tube are too high
- 3) *Filter Unit* – A filter unit is recommended when the samples are likely to contain particulate matter. If the air/gas sample contains heavy hydrocarbon condensate, the filter must be of the coalescing type with a drain. The filter unit should be positioned as close to the sample point as practical.

- 4) *Pressure Reduction Valve or Pressure Regulator* – If the sample is to be measured at atmospheric pressure then the valve 4A should be fitted and 4B omitted from the system. If the sample is to be measured, at full line pressure and the exhaust vented to atmosphere, then valve 4B should be fitted and 4A omitted from the system. If measurements are to be taken at full line pressure and the sample is to be returned to a part of the main line or a vent, which is at a pressure higher than atmospheric, and the input to that line needs a controlled pressure then both 4A and 4B will be required.
- 5) *Sample Pressure Gauge* – This is not a critical part of the moisture measurement but may be required if Dew/Frost point measurements are to be made at higher than atmospheric pressure.
- 6) *Measuring Sensor*.
- 7) *Sensor Holder*.
- 8) *Desiccant Chamber* – This item is required when the sampling is to be intermittent. When installed it prevents the ingress of wet air to the sample system, while the sample is not flowing, improving the response time.
- 9) *Flow Control Valve* – This can be a separate item or combined with the flow indicator.
- 10) *Flow Indicator* – The recommended sample flow is 2 to 3 SL/M.

Sample Exhaust – The exhaust can be vented to atmosphere or returned to the process line as discussed above.

## 2.5 Installing and commissioning the sensor

It is advisable to carry out an initial purge routine of the sample loop, before installing the sensor, in order to remove the possibility of sensor damage on start-up.

Referring to the sample system schematic in section 3.4, open the inlet isolation valve slowly, until a small flow of air/gas at atmospheric pressure flows through the inlet pipe work to the sensor holder and exhausts through the sensor entry port of the sensor holder.

Allow this purge to continue for about 15 to 20 minutes to remove any residual moisture from the sample pipe work and components.

Close the inlet isolation valve and install the sensor into the sensor holder. Securely push fit the coaxial sensor cable connector in position on the sensor.

Open the inlet valve slowly, again and, by opening all valves after the sensor holder, allow a low-pressure purge through the whole sample system. (Note. If a closed by-pass loop is installed, this section of the procedure is not possible).

Set the required pressures and flows within the sample loop.

This completes the installation and commissioning but, on initial start-up, it could take several hours for the system to reach equilibrium.

## 2.6 Installing your dewTEC DS2000 Hygrometer

The dewTEC DS2000 is a standard 1/8<sup>th</sup>-DIN size.

### 2.6.1 Panel mounting cut out

The panel on which your hygrometer is to be mounted must be rigid and up to 6mm thick. The cut out size required is shown in the diagram below.

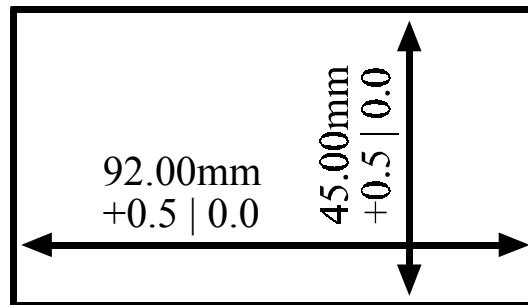

### 2.6.2 Panel mounting

Your hygrometer is supplied with a panel gasket and push-fit fixing strap. Do not remove the panel gasket, as this may result in inadequate clamping of the hygrometer in the panel. Remove the push-fit fixing strap and place the hygrometer through the cut out from the front. Then slide the fixing strap over the hygrometer housing from the rear of the panel until the tongues engage in the ratchets and hygrometer is firmly in place.

## 2.7 Electrical interface connections

The rear terminal houses all connections to the unit. The connections are shown in the diagram below and each input is described further in the following paragraphs. See the full specification given at the end of this manual for more details on the interfaces.

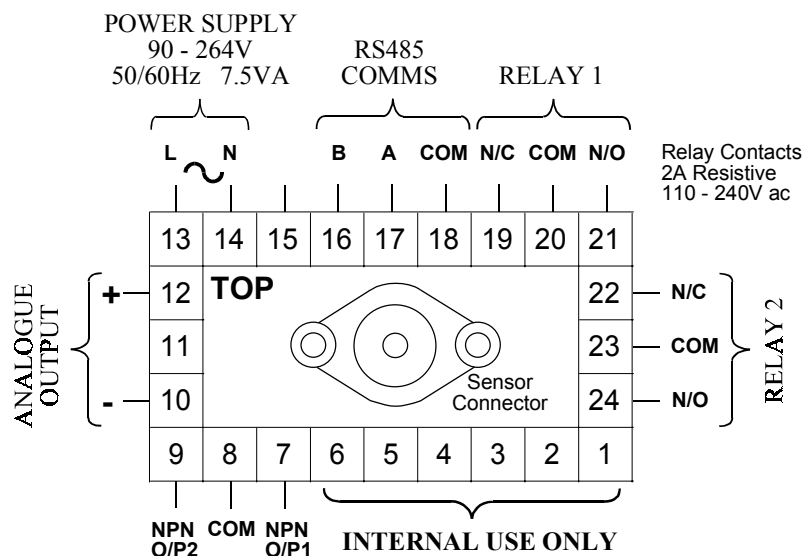

### 2.7.1 Mains (line) supply

The hygrometer will operate on 90-264V AC, 50/60Hz mains (line) voltage. The power consumption is 7.5VA.

An external fuse and a suitable switch or circuit breaker must protect the mains supply of the hygrometer, which should be near the unit. Use a 1A antisurge Fuse.

#### RECOMMENDED POWER CONNECTION

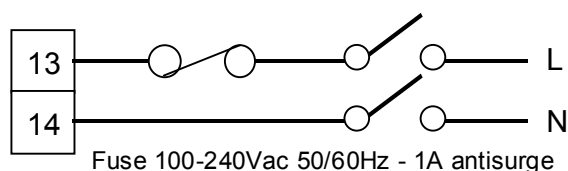

If the relay outputs are to be used to carry mains (line) voltage, it is recommended that the relay mains (line) supply should be switched and fused in a similar manner but should be separate from the hygrometer mains (line) supply.

### 2.7.2 Sensor Connection

The sensor is connected to the hygrometer with the low impedance co-axial cable provided. This low impedance cable may be up to 1 km long.

Note that the body of the sensor is not isolated. It is important that the earth potential at the sensor is the same as that in the power supply earth to avoid stray pick-up. This is very rarely a problem, but if in doubt, check for a voltage between the sensor body and the sensor holder before installing the sensor.

### 2.7.3 Alarm Relay Outputs

The relay outputs of Alarm 1 and 2 are single pole double throw contacts rated at 2A resistive at 120Vac or 240Vac, 50/60Hz.

The relay contacts are inherently isolated from the instrument and from each other.

### 2.7.4 Linear (Analogue re-transmission) Output

A 10-bit analogue signal representing the dewpoint is re-transmitted by the output, which is factory preset to voltage or current output. The range of re-transmission can be set to anywhere within the hygrometers' operating range. See section 4 on how to set your options.

The output is isolated from the rest of the unit and should be wired using a twisted pair or screened wire.

Load Impedance is 500Ω maximum in mA ranges and 500Ω minimum in voltage ranges.

### 2.7.5 Alarm Transistor Open Collector Outputs

The open collector outputs of Alarm 1 and 2 are NPN outputs. The return is common for both collectors.

### 2.7.6 Serial Communications Output

The cable used should be suitable for data transfer at the selected rate (1200, 2400, 4800 or 9600) over the required distance. Transmitters/receivers conform to the recommendations in the EIA Standard RS485.

The “A” terminal on the hygrometer (Terminal 17) should be connected to the “A” terminal on the master device; the “B” terminal on the hygrometer (Terminal 16) should be connected to the “B” terminal on the master device and the “Common” terminal on the hygrometer (Terminal 18) should be connected to the “Common” terminal on the master device.

Where several hygrometers are connected to one master port, the master port transceiver in the active state should be capable of driving a load of 120kΩ per indicator. The masterport transceiver in the passive state must have pull-up/pull-down resistors of sufficiently low impedance to ensure that it remains in the quiescent state whilst supplying up to ±100μA each to the hygrometer transceivers in the high impedance state.

### 2.7.7 External Autocal Control

An external autocal potentiometer can be added to control the setting remotely.

Connect a 20kΩ multi-turn potentiometer (20 turn or better) using a twisted pair or screened cable between pins one and three. Wire the external potentiometer to increase resistance when turned clockwise (Increasing the resistance will increase the display value).

Note, to use the external control, the internal control on the rear terminal needs to be turned fully clockwise (see section 4).

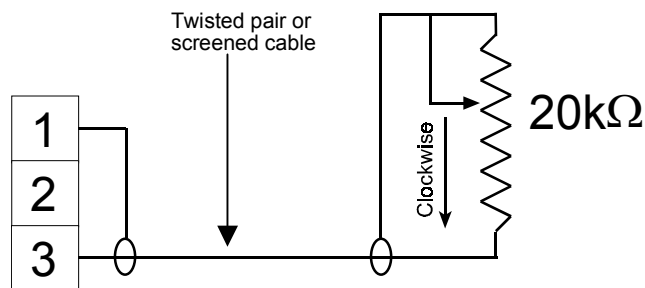

## 3.0 Operating Instructions

*This section covers day-to-day operation of the dewpoint meter.*

### 3.1 Start Up

On power up, with the sensor connected, the unit will display the process value in dewpoint (or PPM(v) if factory preset). Typical warm up time is 3 minutes.

### 3.2 Front Panel Display and Keys

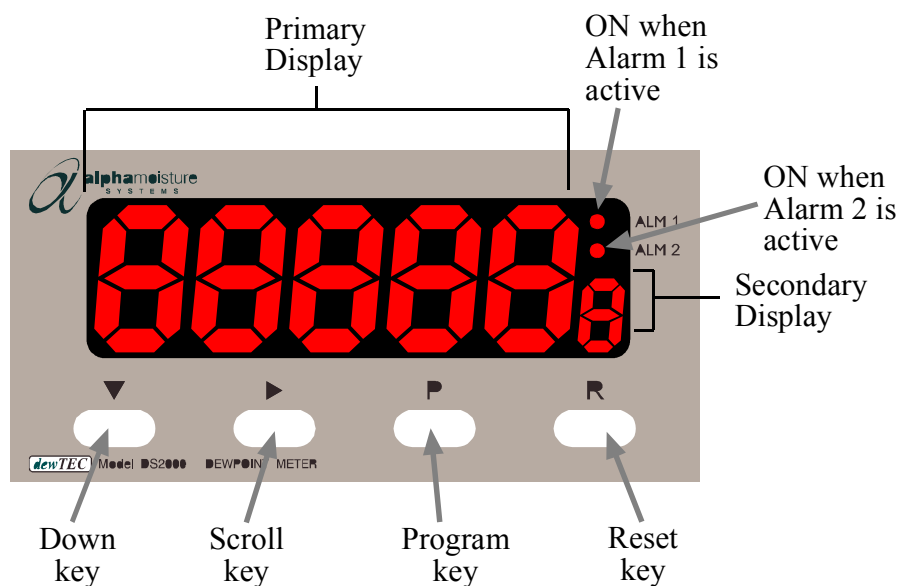

Key / Display / Indicator	Function
Primary Display	Normally displays the process Dewpoint/Moisture value. Operational programmed parameters can be viewed by pressing the Programme key ( <b>P</b> ). The display will indicate the parameter description for three seconds before showing the parameter value. (Note: this function will only operate if the <i>Help Facility</i> is enabled - see section 4, Dewpoint Meter Settings).
Secondary Display	This single character identifier highlights the parameter value being displayed - not lit when normally displaying the process Dewpoint/ Moisture value.
Down key (▼)	In Edit Mode, decrements the flashing/blinking digit in the Primary Display.
Scroll key (▶)	Puts the Dewpoint meter into Edit Mode. In Edit Mode this key selects the digit to be altered in Primary Display - digit selected for alteration flashes/blinks.
Program Key ( <b>P</b> )	Selects parameter to be viewed/edited. In Edit Mode this key confirms edited parameter value.
Reset Key ( <b>R</b> )	When in normal display mode, pressing this key resets a latched alarm condition. Also resets the Maximum (High) Value, Minimum (Low) Value or Alarm1 Elapsed Time, whichever parameter is displayed,
Down and Scroll Keys (▼) & (▶)	When pressed simultaneously in Edit Mode, the unit will abort the Edit operation and will restore the parameter to its initial value.
ALM 1 and ALM 2	LED Indicators lit (in all operation modes) when in alarm condition.

### 3.3 Viewing Operating Mode Parameters

The flow diagram below shows the viewable parameters that are scrolled through as the program key (**P**) is pressed:

**Initial Display at Start Up.** Displays your process Dewpoint.

Maximum (High) Dewpoint since last reset. To reset, press the (**R**) key when displayed.

Minimum (Lo) Dewpoint since last reset. To reset, press the (**R**) key when displayed.

Accumulated time that Alarm 1 has been active since last reset. This display format is in **mm.ss** up to 99 minutes and 59 seconds, after which the format changes to **mmm.s**. To reset, press the (**R**) key when displayed.

Dewpoint at and above which (Process High Alarm) or at and below which (Process Low Alarm) Alarm 1 is active. To set press (**P**) when displayed and follow the instructions given in paragraph 3.4.

Defines the width of the hysteresis band in dewpoint applied on the 'safe' side of the Alarm 1 level. Set in the same manner as Alarm value.

Dewpoint at and above which (Process High Alarm) or at and below which (Process Low Alarm) Alarm 2 is active. To set press (**P**) when displayed and follow the instructions given in paragraph 3.4.

Defines the width of the hysteresis band in dewpoint applied on the 'safe' side of the Alarm 2 level. Set in the same manner as Alarm value.

Total value based upon integration of the input signal using the time base set in the hygrometer settings.

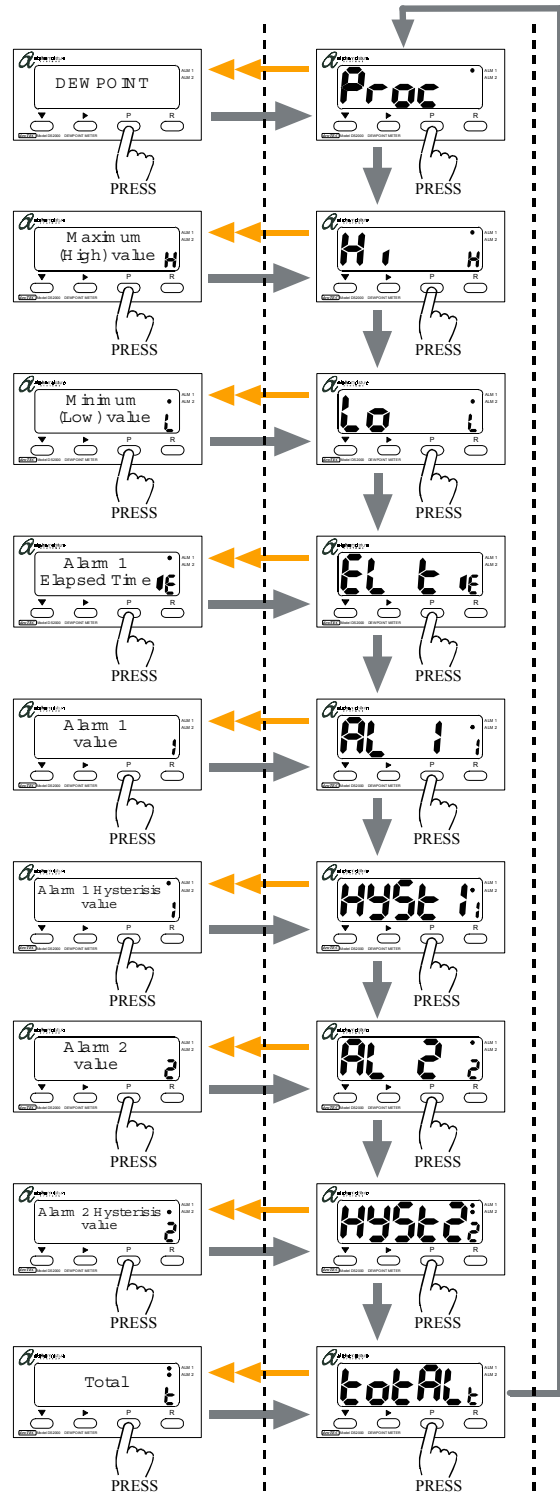

**NOTE:** These displays will not appear if the **Help** function is disabled

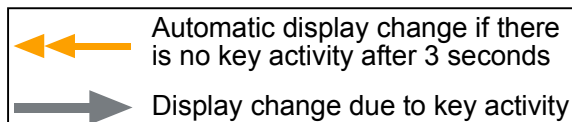



### 3.4 Setting the Alarms and hysteresis

Note, Alarm settings cannot be changed if the alarm **LOCK** is enabled in the hygrometer program settings.

Edit mode for Alarm 1, Alarm 2 and hysteresis settings can be entered by pressing the scroll key (▶) when the parameter is displayed. This is the first step shown in the flow diagram below. Follow the rest of the steps shown in the diagram to set your required value.

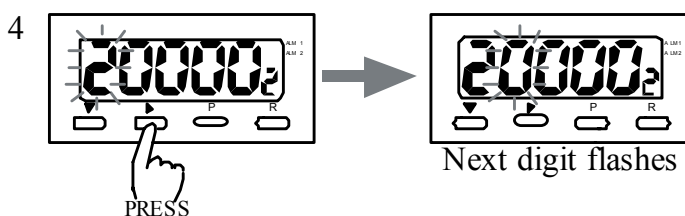
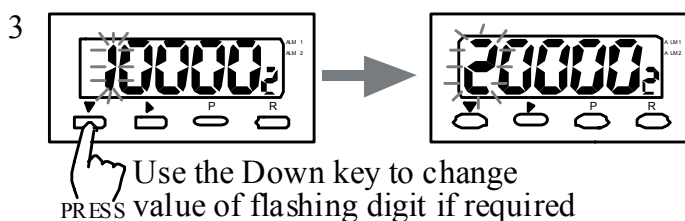
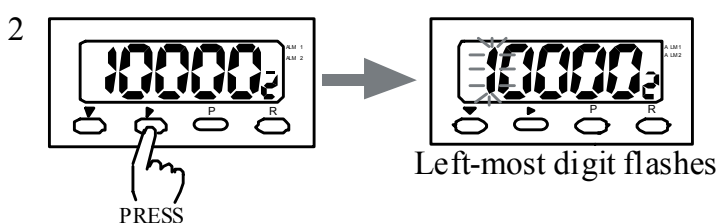
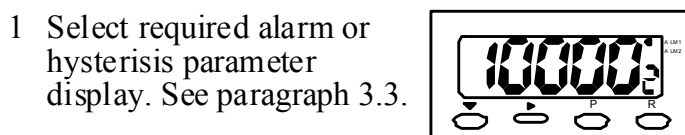

5 Repeat steps 3 and 4 for each digit required

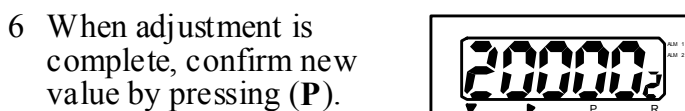

All digits will stop flashing and new value will be displayed. Display is now back in operating mode at the point where the setting mode was entered.

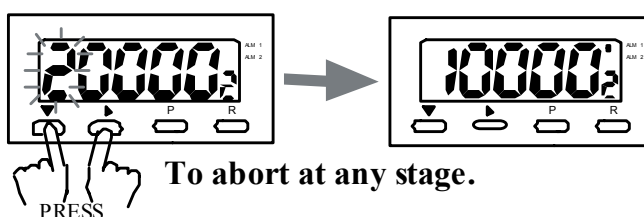

**Note:** if in edit mode no key activity occurs for 90 seconds, the hygrometer automatically returns to operation mode at the point where the setting mode was entered and cancels any changes made.

### 3.5 Hysterisis Operation

Operation of the hysterisis depends on whether the alarm is set to trip on high or low. The diagram below shows how the hysterisis functions in each mode.

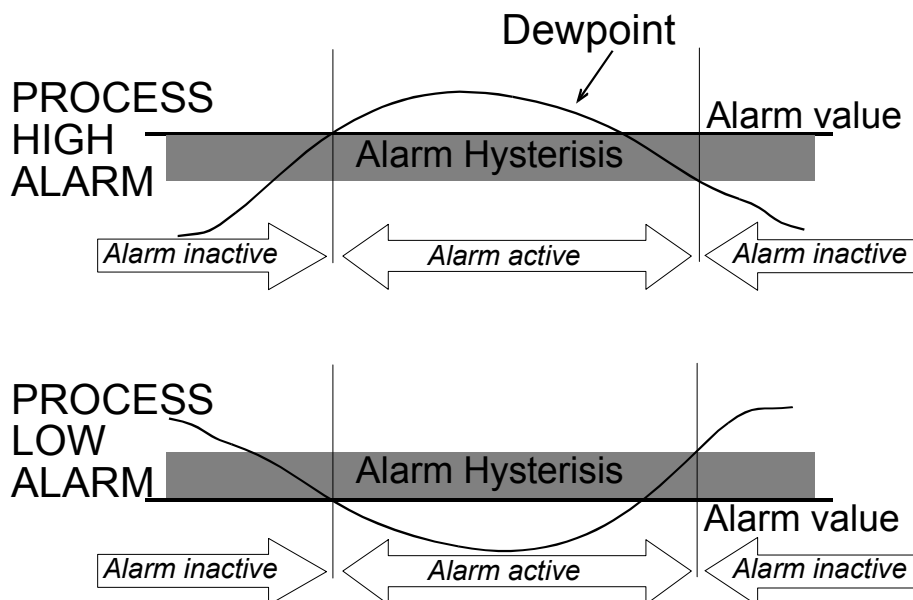

### 3.6 Resetting a latched Alarm

If Alarm 1 is configured to be a latching alarm relay when it is active, it can be reset as follows:

- 1 Ensure Dewpoint is displayed

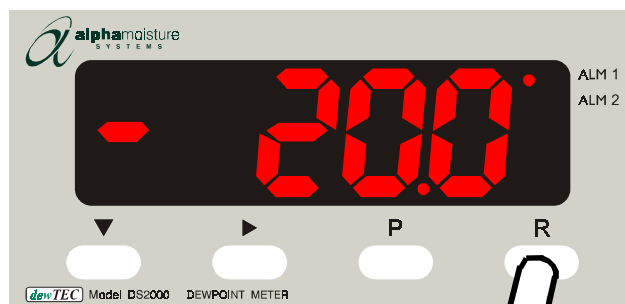

- 2 Press reset key (R)

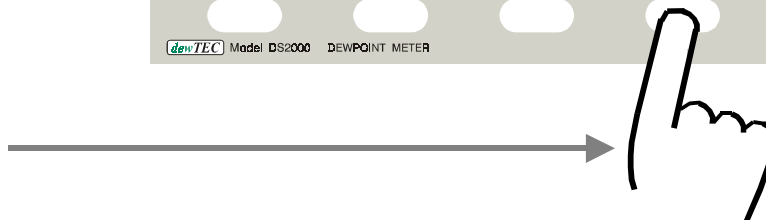

Note, the latched alarm cannot be reset whilst the alarm condition persists.

## 4.0 Hygrometer Settings

### 4.1 Sensor Calibration (AUTOCAL)

One of the most valuable advantages of the sensors is the Autocal feature.

The system relies on the fact that each sensor is designed to vice no further increase in reading when it reaches its maximum moisture level. This means that the sensor will read its maximum value when it is exposed to gas or air that is at that level and will continue to read that value when it is exposed to wetter gas. The system can therefore be calibrated to the analyser, on site, very simply by exposing the sensor to anything wetter than the maximum level and adjusting the reading to the maximum dewpoint, on the hygrometer display, using the Autocal Control on the hygrometer rear panel.

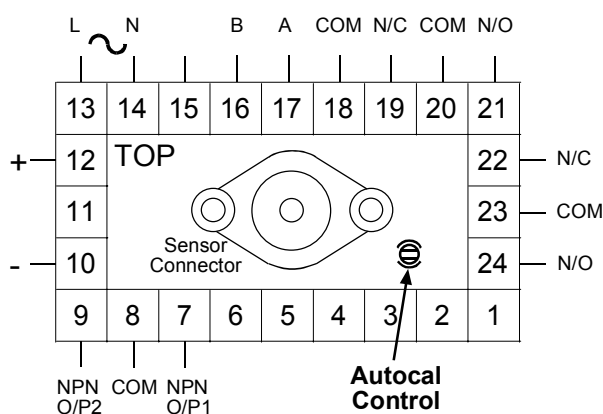

Factory calibration is performed by comparing readings given from the hygrometer with readings obtained from a primary standard, traceable to The British Standard moisture generator held at the National Physical Laboratory. These comparative readings are taken after the sensor has been set to automatic calibration and the results are shown in the calibration certificate supplied with each sensor.

To autocal the sensor, follow these simple steps:

1. Disconnect the coaxial cable from the sensor. Remove the sensor from its normal position so it is exposed to ambient air or hold in the palm of the hand if the sensor full range is +20°C dewpoint.
2. Leave the sensor for approximately five minutes (this time is not critical but the hygrometer reading should be stable before any adjustment is made. It is not advisable to leave the sensor exposed to ambient air for more than a few minutes as this will impair dry-down when the sensor is re-installed).
3. IF NECESSARY, adjust the Autocal control, on the analyser front panel, until the display indicates the maximum level for the sensor range in use.

4. Disconnect the coaxial cable and re-install the sensor in its normal position. Reconnect the coaxial cable.

This procedure re-confirms that the sensor is correctly calibrated to the hygrometer.

We recommend that verification of the overall linearity of calibration of the system should be carried out on a 12 monthly basis.

## 4.2 Programmed Settings

The *dewTEC* DS2000 has two setting modes that modify the hygrometers' operation. The modes and parameters are shown in the following table:

MODE	PARAMETER
Program Mode	Calibration Data, Decimal Point Position, Linear Output scaling, Offset, Filter, Communications address and baud rate, Display Colour, Lock, Help on/off
Configuration Mode	Alarm Mode, Alarm Direction, Linear Output type, Totaliser

Enter the mode that you require as described in this section to change a parameter.

**NOTE:** Many of the parameters are factory set during manufacture, test and calibration. Do not change any of these settings as your hygrometer may give erroneous readings without you knowing.

### 4.2.1 Program Mode

To enter Program Mode  
(and to exit Program Mode)

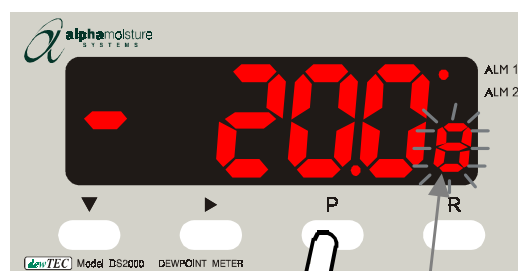

Press and hold (P) for 3 seconds

In program mode, the secondary display flashes continuously and shows a single character, which identifies the displayed parameter.

Once in Program Mode, follow these instructions to view and set parameters:

- Press (P) to scroll through the program mode parameters (as described in paragraph 3.3 for the operating parameters).
- To edit any displayed parameter, press (▶) to enter edit mode and (▼) to decrement any digit (as described in paragraph 3.4 for setting the alarms).

The following table gives the program mode parameters and their sequence.

Primary Display	Identifier (Flashing)	Description	Adjustment Range	STATUS								
ScA 1	1	Scaling Point 1. The first sensor input value point (expressed as a percentage of input span) which is used to establish a curve for scaling sensor input values into engineering unit values (°C or °F)	0.00% to 100.00% of input span	Factory setting. Do not change.								
d.5 1	.1	Display Point 1. The engineering unit value corresponding to Scaling Point 1.	-19999 to 19999	Factory setting. Do not change								
ScA 2	2	Scaling Point 2. The first sensor input value point (expressed as a percentage of input span) which is used to establish a curve for scaling sensor input values into engineering unit values (°C or °F)	0.00% to 100.00% of input span	Factory setting. Do not change								
d.5 2	.2	Display Point 2. The engineering unit value corresponding to Scaling Point 2.	-19999 to 19999	Factory setting. Do not change								
The scaling process can be continued up to 10 Scaling Points and 10 Display Points, until a scaling point is given the value 100.0%. This will be the final scaling point offered. Note, the hygrometer only allows Scaling Point 1 ≤ Scaling Point 2 ≤ Scaling Point 3 etc.												
dEc P	P	Decimal Point Position. Defines the decimal point position for the dewpoint display and alarm values.	0 to 0.0000	Factory setting. Do not change								
rt Lo	L	Re-transmission Scale Minimum. The lower end of the linear scale for the re-transmission output, expressed as the value corresponding to the minimum output signal.	-19999 to 19999	User adjustable setting.								
rt H	H	Re-transmission Scale Maximum. The upper end of the linear scale for the re-transmission output, expressed as the value corresponding to the maximum output signal.	-19999 to 19999	User adjustable setting.								
OFF	O	Offset. Offsets the input by a fixed amount.	-19999 to 19999	Not normally required.								
Filt	F	Input Filter Time Constant. Filters the input over a user definable time period to minimise the effect of noise and impulses	0.0 (OFF) to 100.0	Normally set to zero. User settable in noisy environments								
Addr	A	Communication Address. The unique serial communications address of the hygrometer	1 to 99	User adjustable setting.								
BAud	b	Baud Rate. Serial Communications speed	1200, 2400, 4800 or 9600	User adjustable setting.								
Color	C	Display Colour Change. Defines the colour of the primary and secondary displays prior to/after the alarm level is reached	<table border="1"> <tr><td>red</td><td>Red</td></tr> <tr><td>GrEEn</td><td>Green</td></tr> <tr><td>Gr.rd</td><td>Green to Red</td></tr> <tr><td>rd.Gr</td><td>Red to Green</td></tr> </table>	red	Red	GrEEn	Green	Gr.rd	Green to Red	rd.Gr	Red to Green	User adjustable setting.
red	Red											
GrEEn	Green											
Gr.rd	Green to Red											
rd.Gr	Red to Green											
Lock	L	Alarm Lock. Enables/Disables the changing of alarm settings via the front panel.	<table border="1"> <tr><td>En</td><td>Enabled</td></tr> <tr><td>d.5</td><td>Disabled</td></tr> </table>	En	Enabled	d.5	Disabled	User adjustable setting.				
En	Enabled											
d.5	Disabled											
HELP	h	Help Prompt. Determines whether the Primary Display shows the parameter description for 3 seconds before a parameter value is shown.	<table border="1"> <tr><td>HL P Y</td><td>Yes</td></tr> <tr><td>HL P N</td><td>No</td></tr> </table>	HL P Y	Yes	HL P N	No	User adjustable setting.				
HL P Y	Yes											
HL P N	No											

Remember that if Help is enabled, the Primary Display shows the Displays given above and the parameter value after three seconds.

## 4.2.2 Configuration Mode

To enter Configuration Mode  
(and to exit Configuration Mode)



Press and hold (▼) and (P) simultaneously for 3 seconds

→ In configuration mode, the secondary display flashes continuously and shows a single character, which identifies the displayed parameter.

Once in Configuration Mode, follow these instructions to view and set parameters:

- Press (P) to scroll through the configuration mode parameters (as described in paragraph 3.3 for the operating parameters).
- To edit any displayed parameter, press (▶) to enter edit mode and (▼) to decrement any digit (as described in paragraph 3.4 for setting the alarms).

The following table gives the parameters and their sequence.

Primary Display	Identifier (Flashing)	Description	Adjustment Range		STATUS
			Display	Description	
InPt		Input Range	2900	Sensor	Factory setting. Do not change
Freq	F	Power Supply Frequency	50 60	50Hz 60Hz	Automatically set.
AL 1	1	Alarm 1 Type. Defines the action of Alarm 1	P.H. P.Lo none	Process High Process Low No Alarm	User adjustable setting
AL 2	2	Alarm 2 Type. Defines the action of Alarm 2	P.H. P.Lo none	Process High Process Low No Alarm	User adjustable setting
Out	U	Output 1 Direction. Determines how NPN Output 1 and Relay 1 operate	A.ln A.ln A.ln A.ln O.ln O.ln	Alarm 1 non-latching, direct action Alarm 1 non-latching, reverse action Alarm 1 latching, direct action Alarm 1 latching, reverse action Logical OR Alarms 1 & 2, direct action Logical OR Alarms 1 & 2, reverse action	User adjustable setting

Out 2	u	Output 1 Direction. Determines how NPN Output 1 and Relay 1 operate	Al2.d	Alarm 2, direct action	User adjustable setting
			Al2.r	Alarm 2, reverse action	
			012d	Logical OR Alarms 1 & 2 direct action	
			012r	Logical OR Alarms 1 & 2 reverse action	
rt Enc	t	Re-transmission (Linear) Output  Selects the output range.  <b>NOTE;</b> The hygrometer is factory set to give either voltage or current outputs. See the specification sheet and your order for your hygrometer setting.	none	None	User adjustable setting
			0-5v	0 – 5V	
			1-5v	1 – 5V	
			0-10v	0 – 10V	
			2-10v	2 – 10V	
			0-20A	0 – 20mA	
			4-20A	4 – 20mA	
OPEn	o	Communications Enable/Disable  Only disable this function if comms. is giving you a problem.	none	None/Disabled	User adjustable setting
			Coms	Comms. Enabled	
			Sety	Not available	
			EA-E	Not available	
tot	t	Totaliser Timebase.	Sec	Seconds	User adjustable setting
			Min	Minutes	
			hr	Hours	

## 5.0 Serial Communications

The Serial Communications Port is a standard RS485 communications link. Up to 32 standard RS485 loads may be present in a single loop on this link.

### 5.1 Data Format/Baud Rate

Data is format as a 10-bit data word i.e.	1	Start bit
	7	Data bits
	1	Parity bit (even parity)
and	1	Stop bit

Supported Baud Rates are 1200, 2400, 4800, 9600 bits/second

The half-duplex line turn-round time is fixed at 6ms regardless of baud rate.

The maximum inter-character delay is 120ms.

The No Reply timeout is 2 seconds.

### 5.2 Protocol

The protocol operates on a single master basis. The master device initiates all communication. The hygrometer acts as a slave device.

### 5.3 Message Format

Each message starts with a Start of Message character (L) and finishes with an End of Message character (\*). A reply from the addressed instrument will contain either a positive acknowledgement or a negative acknowledgement. A positive acknowledgement has the character "A" immediately preceding the End of Message character; a negative acknowledgement has the character "N" immediately preceding the End of Message character.

There are two message formats; they permit instrument identification, Parameter Read operations and Parameter Write operations.

#### 5.3.1 Message Form 1

The master device sends a Form 1 message to ascertain whether an instrument occupies a specific communications address. If there is an instrument at that address, a reply (with a positive acknowledgement) is received. If there is no instrument at that address or there is a communications link failure, no reply is received. The message from the master device must be of the form:

Laa??\*

where **aa** is the address (a two digit hexadecimal number). The reply from the addressed instrument is of the form:

Laa?A\*

Where **aa** is the same address as in the received message.



### 5.3.2 Message Form 2

This message implements a Parameter Read operation. The message from the master device is of the form:

Laap?\*  
 where            **aa** is the address (a two digit hexadecimal number)  
                          **p** is a single character parameter identifier (see table below)

The reply, if the Parameter Read operation is successful, is of the form

LaapnnnnA\*

where            **aa** is the same address as in the received message  
                          **p** is a single character parameter identifier (see table below)  
                          **nnnnn** is the data (a five digit hexadecimal number)

If the specified parameter is invalid (e.g. not applicable to the addressed instrument), the reply is of the form:

Laap00000A\*

where            **aa** is the same address as in the received message  
                          **p** is a single character parameter identifier (see table below)

Identifier	Hex.	Parameter	Range
:	3A	Dewpoint	Depending on factory set range
;	3B	Total Value	-19999 to 99999
<	3C	Maximum Dewpoint	-19999 to 99999
=	3D	Minimum Dewpoint	-19999 to 99999
>	3E	Elapsed Alarm 1 Time	0 to 60000
E	45	Alarm 1 Dewpoint	Range Maximum to Range Minimum
F	46	Alarm 2 Dewpoint	Range Maximum to Range Minimum

### 5.4 Error Conditions

If a slave detects a syntax error or parity error, it will not reply to the message; the master device should make up to two retries, applying the two second No Reply timeout in each case. Parameter read operations with parameter identifiers which are not applicable to the addressed instrument, will have no effect and a positive acknowledgement will be returned.

## 6.0 Maintenance and Troubleshooting



### 6.1 Maintenance

The dewTEC DS2000 front panel can be wiped clean when necessary with a damp soft cloth. The hygrometer contains no user serviceable parts. Do not open the unit. The rear of the unit can be dusted with a dry cloth if necessary. Ensure that no voltages are present on the rear terminal when this is done.

The sensor body may be wiped down with a dry cloth. Do not attempt to clean the sensor element as it may be damaged.

### 6.2 Problem Guide

(To be checked in a safe area by a technician experienced in handling similar equipment)

Problem	Cause	Solution
Display reads 	Sensor cable or plug short circuit.  Short Circuit Sensor  Instrument unserviceable  Autocal wrongly set	Disconnect the sensor cable plug from the sensor and if the hygrometer still reads the same, repair the short circuit in the cable or plug.  Disconnect the sensor cable plug from the sensor. If the display now indicates <u>Under</u> or zero. Apply approximately 24V DC to the sensor terminals MOMENTARILY with the sensor in a dry condition. Polarity is not important, but the contact must be brief or the sensor will be destroyed. If this fails to clear the fault, the sensor must be replaced.  Disconnect sensor cable from the instrument. If reading does not change, return instrument for service.  Re adjust autocal as described in this manual.
Display reads 	Wet Gas or free water in system  Autocal wrongly set	Stop gas supply and switch instrument off. Check drain and inspection ports in the main system and sample system.  Re adjust autocal as described in this manual.
Display reads  or zero continuously	Open circuit cable  Open circuit sensor  Instrument unserviceable	Disconnect sensor cable and check continuity. Repair or replace cable.  Check continuity to body of sensor. Disconnect sensor cable. Short circuit cable terminals and if display indicates <u>brEAr</u> , replace sensor.  Disconnect sensor. Short circuit cable terminals and if display does not indicate <u>brEAr</u> , return instrument for service.
Wet Reading	Leak in system or use of unsuitable pipe  Comparison with Secondary Standard Instrument or Calibration Gas	Cure the leak or replace unsuitable pipe with copper or stainless steel. Flexible connection should be made with PTFE pipe. NEVER use rubber or plastic pipe.  Ensure that samples are taken from same sample point. Re-check Autocal setting. If problems still occur re-calibration of the system is recommended

<b>Problem</b>	<b>Cause</b>	<b>Solution</b>
Slow Response	Free water in system	Check drain & inspection ports in the main system & sample pipe work.
	Wrongly sized or incorrect material in sample lines	Refer to installation section of this manual & ensure sample tube material & flow rates are as recommended.
Dry Reading	Autocal wrongly set	Re adjust autocal as described in this manual. If this does not cure problem replace sensor & return original for calibration.
	Comparison with Secondary Instrument or Calibration Gas	Re adjust autocal as described in this manual. If this does not cure problem re-calibration of the system is recommended.
Constant Reading	Condensation in Sample System	Condensation will occur if the temperature of the sample system or main pipe, at any point is below (colder) than the DP temperature of the sample gas. Once having formed, the sample reaching the sensor will have a DP equal to the temperature of the condensate, regardless of the DP at the sample point

## Appendices

### Appendix A – Product Specification

#### 1. Display

Type: Red/green, 7-segment, 5-digit primary display, 1-digit secondary display.  
 Height: 18mm (0.71 inches) primary display, 7mm (0.3 inches) secondary display  
 Annunciators: Alarm 1 and Alarm 2 status

#### 2. Sensor

Dewpoint Range: From  $-110^{\circ}\text{C}$  to  $+20^{\circ}\text{C}$   
 Accuracy:  $\pm 2^{\circ}\text{C}$  over full range  
 Operating Temperature:  
 Storage Temperature:  
 Mechanical Connections:  
 Electrical Connection: Male coaxial plug  
 Approvals: CE, Atex -

#### 3. Hygrometer Input

Sampling Rate: 10Hz  
 Resolution: 14-bits  
 Sensor short circuit detection: Detected within two seconds. All alarms become active

#### 4. Transistor Outputs

Type: NPN open collector. Output 1 tied to Alarm 1. Output 2 tied to Alarm 2.

#### 5. Relay Output 1

Contact Type: Single pole, double throw  
 Rating: 2A resistive, 120/240V, 50/60Hz  
 Lifetime: >500,000 operations at rated voltage/current  
 Isolation: Inherent

#### 6. Relay Output 2

Contact Type: Single pole, double throw  
 Rating: 2A resistive, 120/240V, 50/60Hz  
 Lifetime: >500,000 operations at rated voltage/current  
 Isolation: Inherent

#### 7. Linear (Re-Transmitted) Output

Ranges Available: 0-5V, 1-5V, 1-10V, 2-10V, 0-20mA and 4-20mA  
 Accuracy:  $\pm 0.5\%$  max of display value  
 Load Impedance:  $500\Omega$  max for mA ranges,  $500\Omega$  min for voltage ranges

#### 8. Serial Communications

Type: Serial asynchronous, UART to UART  
 Data Format: Open ASCII; one start bit, even parity, seven data bits and one stop bit.  
 Physical Layer: RS485  
 Maximum Number of zones: 99  
 Baud Rate: Selectable – 1200, 2400, 4800 or 9600

#### 9. Performance

##### Reference Conditions

Ambient Temperature:  $20^{\circ}\text{C} \pm 2^{\circ}\text{C}$   
 Relative Humidity: 60 – 70%  
 Supply Voltage: 90 – 264V, 50Hz

##### Operating Conditions

Ambient Temperature:  $0^{\circ}\text{C} \pm 55^{\circ}\text{C}$   
 Relative Humidity: 20 – 95% non-condensing

#### 10. Environmental

Approvals: CE  
 EMC: Certified to EN61326

Notes: 1) For RF fields (10V/m 80% Am, 1kHz) the reading accuracy may be impaired by up to  $-0.3\%$  in the frequency band 87 to 109MHz.  
 2) For line-conducted disturbances induced by RF fields (10V 80% AM 1kHz). The instrument is self recoverable in the frequency band 0.15-0.73 Hz

Safety: Complies with EN61010-1  
 Front Panel Seal: To IP66  
 Supply Voltage: 90 – 264V, 50/60Hz  
 Power Consumption: 7.5VA max

#### 11. Physical

Dimensions: Height – 48mm  
 Width – 95mm  
 Depth – 110mm without sensor connector.  
 Weight: 0.21 kg max.  
 Mounting: Panel-mount; press-fit fixing. Panel cut out – 45mm x 92mm.  
 Terminals: Screw type

## Appendix B – General Arrangement

